

Name: _____

$3 + 4 = \underline{\quad}$

$6 + 3 = \underline{\quad}$

$1 + 6 = \underline{\quad}$

$13 + 4 = \underline{\quad}$

$16 + 3 = \underline{\quad}$

$11 + 6 = \underline{\quad}$

$23 + 4 = \underline{\quad}$

$26 + 3 = \underline{\quad}$

$21 + 6 = \underline{\quad}$

$7 + 2 = \underline{\quad}$

$8 + 2 = \underline{\quad}$

$6 + 0 = \underline{\quad}$

$17 + 2 = \underline{\quad}$

$18 + 2 = \underline{\quad}$

$16 + 0 = \underline{\quad}$

$27 + 2 = \underline{\quad}$

$28 + 2 = \underline{\quad}$

$26 + 0 = \underline{\quad}$

$9 + 1 = \underline{\quad}$

$4 + 5 = \underline{\quad}$

$2 + 2 = \underline{\quad}$

$19 + 1 = \underline{\quad}$

$14 + 5 = \underline{\quad}$

$12 + 2 = \underline{\quad}$

$29 + 1 = \underline{\quad}$

$24 + 5 = \underline{\quad}$

$22 + 2 = \underline{\quad}$

$5 + 1 = \underline{\quad}$

$3 + 3 = \underline{\quad}$

$4 + 1 = \underline{\quad}$

$15 + 1 = \underline{\quad}$

$13 + 3 = \underline{\quad}$

$14 + 1 = \underline{\quad}$

$25 + 1 = \underline{\quad}$

$23 + 3 = \underline{\quad}$

$24 + 1 = \underline{\quad}$



Name: _____

$3 - 2 = \underline{\quad}$

$5 - 1 = \underline{\quad}$

$9 - 6 = \underline{\quad}$

$13 - 2 = \underline{\quad}$

$15 - 1 = \underline{\quad}$

$19 - 6 = \underline{\quad}$

$23 - 2 = \underline{\quad}$

$25 - 1 = \underline{\quad}$

$29 - 6 = \underline{\quad}$

$8 - 8 = \underline{\quad}$

$7 - 5 = \underline{\quad}$

$3 - 1 = \underline{\quad}$

$18 - 8 = \underline{\quad}$

$17 - 5 = \underline{\quad}$

$13 - 1 = \underline{\quad}$

$28 - 8 = \underline{\quad}$

$27 - 5 = \underline{\quad}$

$23 - 1 = \underline{\quad}$

$1 - 0 = \underline{\quad}$

$2 - 2 = \underline{\quad}$

$4 - 3 = \underline{\quad}$

$11 - 0 = \underline{\quad}$

$12 - 2 = \underline{\quad}$

$14 - 3 = \underline{\quad}$

$21 - 0 = \underline{\quad}$

$22 - 2 = \underline{\quad}$

$24 - 3 = \underline{\quad}$

$6 - 5 = \underline{\quad}$

$8 - 3 = \underline{\quad}$

$5 - 5 = \underline{\quad}$

$16 - 5 = \underline{\quad}$

$18 - 3 = \underline{\quad}$

$15 - 5 = \underline{\quad}$

$26 - 5 = \underline{\quad}$

$28 - 3 = \underline{\quad}$

$25 - 5 = \underline{\quad}$

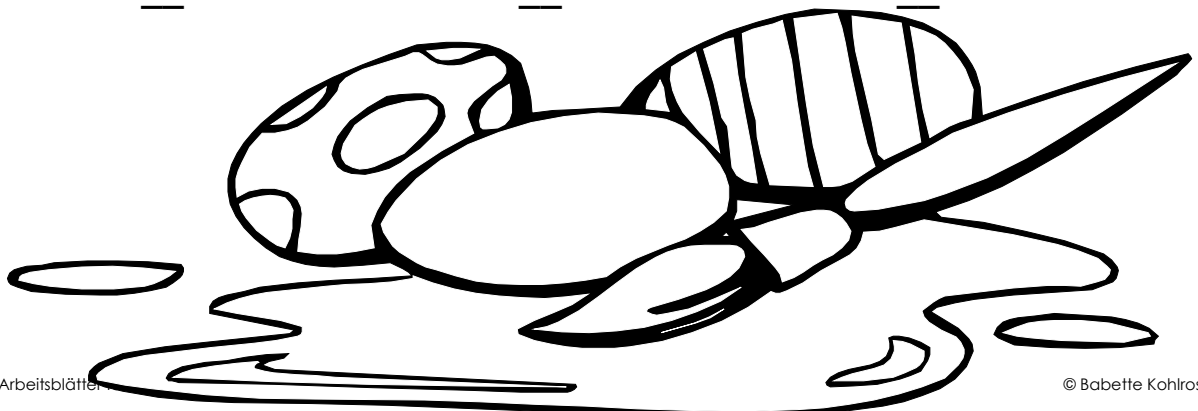

Name: _____

$2 + 1 = \underline{\quad}$

$3 + 5 = \underline{\quad}$

$9 + 0 = \underline{\quad}$

$12 + 1 = \underline{\quad}$

$13 + 5 = \underline{\quad}$

$19 + 0 = \underline{\quad}$

$22 + 1 = \underline{\quad}$

$23 + 5 = \underline{\quad}$

$29 + 0 = \underline{\quad}$

$8 - 3 = \underline{\quad}$

$5 - 2 = \underline{\quad}$

$2 - 1 = \underline{\quad}$

$18 - 3 = \underline{\quad}$

$15 - 2 = \underline{\quad}$

$12 - 1 = \underline{\quad}$

$28 - 3 = \underline{\quad}$

$25 - 2 = \underline{\quad}$

$22 - 1 = \underline{\quad}$

$7 + 3 = \underline{\quad}$

$9 + 1 = \underline{\quad}$

$2 + 5 = \underline{\quad}$

$17 + 3 = \underline{\quad}$

$19 + 1 = \underline{\quad}$

$12 + 5 = \underline{\quad}$

$27 + 3 = \underline{\quad}$

$29 + 1 = \underline{\quad}$

$22 + 5 = \underline{\quad}$

$6 - 2 = \underline{\quad}$

$9 - 7 = \underline{\quad}$

$7 - 4 = \underline{\quad}$

$16 - 2 = \underline{\quad}$

$19 - 7 = \underline{\quad}$

$17 - 4 = \underline{\quad}$

$26 - 2 = \underline{\quad}$

$29 - 7 = \underline{\quad}$

$27 - 4 = \underline{\quad}$

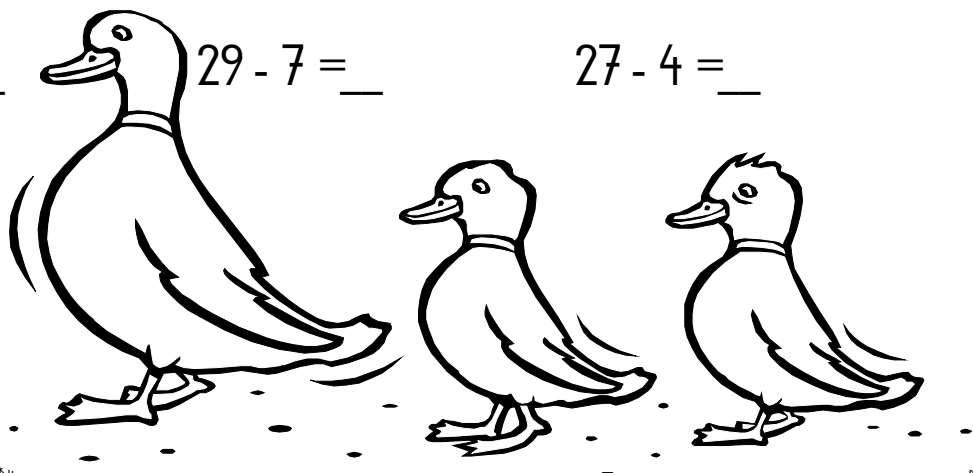

Name: _____

$1 - 1 = \underline{\quad}$

$7 - 5 = \underline{\quad}$

$9 - 7 = \underline{\quad}$

$11 - 1 = \underline{\quad}$

$17 - 5 = \underline{\quad}$

$19 - 7 = \underline{\quad}$

$21 - 1 = \underline{\quad}$

$27 - 5 = \underline{\quad}$

$29 - 7 = \underline{\quad}$

$5 - 4 = \underline{\quad}$

$3 - 2 = \underline{\quad}$

$9 - 8 = \underline{\quad}$

$15 - 4 = \underline{\quad}$

$13 - 2 = \underline{\quad}$

$19 - 8 = \underline{\quad}$

$25 - 4 = \underline{\quad}$

$23 - 2 = \underline{\quad}$

$29 - 8 = \underline{\quad}$

$6 - 0 = \underline{\quad}$

$7 - 7 = \underline{\quad}$

$2 - 2 = \underline{\quad}$

$16 - 0 = \underline{\quad}$

$17 - 7 = \underline{\quad}$

$12 - 2 = \underline{\quad}$

$26 - 0 = \underline{\quad}$

$27 - 7 = \underline{\quad}$

$22 - 2 = \underline{\quad}$

$8 - 4 = \underline{\quad}$

$0 - 0 = \underline{\quad}$

$6 - 3 = \underline{\quad}$

$18 - 4 = \underline{\quad}$

$10 - 0 = \underline{\quad}$

$16 - 3 = \underline{\quad}$

$28 - 4 = \underline{\quad}$

$20 - 0 = \underline{\quad}$

$26 - 3 = \underline{\quad}$



Name: _____

$3 + _ = 5$

$2 + _ = 6$

$13 + _ = 15$

$12 + _ = 16$

$23 + _ = 25$

$22 + _ = 26$

$6 + _ = 9$

$0 + _ = 7$

$16 + _ = 19$

$10 + _ = 17$

$26 + _ = 29$

$20 + _ = 27$

$9 + _ = 9$

$2 + _ = 8$

$19 + _ = 19$

$12 + _ = 18$

$29 + _ = 29$

$22 + _ = 28$

$1 + _ = 5$

$3 + _ = 7$

$11 + _ = 15$

$13 + _ = 17$

$21 + _ = 25$

$23 + _ = 27$

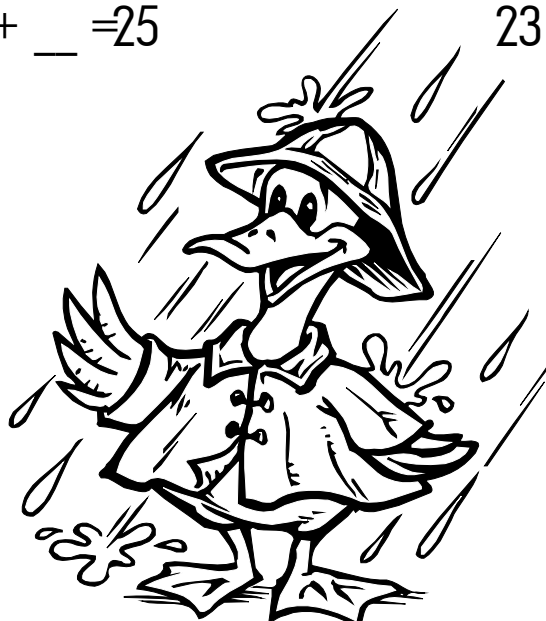

Name: _____

$2 + 3 = \underline{\quad}$

$3 + 6 = \underline{\quad}$

$1 + 5 = \underline{\quad}$

$12 + 3 = \underline{\quad}$

$13 + 6 = \underline{\quad}$

$11 + 5 = \underline{\quad}$

$22 + 3 = \underline{\quad}$

$23 + 6 = \underline{\quad}$

$21 + 5 = \underline{\quad}$

$4 - 3 = \underline{\quad}$

$7 - 6 = \underline{\quad}$

$9 - 5 = \underline{\quad}$

$14 - 3 = \underline{\quad}$

$17 - 6 = \underline{\quad}$

$19 - 5 = \underline{\quad}$

$24 - 3 = \underline{\quad}$

$27 - 6 = \underline{\quad}$

$29 - 5 = \underline{\quad}$

$5 + 5 = \underline{\quad}$

$3 + 7 = \underline{\quad}$

$1 + 1 = \underline{\quad}$

$15 + 5 = \underline{\quad}$

$13 + 7 = \underline{\quad}$

$11 + 1 = \underline{\quad}$

$25 + 5 = \underline{\quad}$

$23 + 7 = \underline{\quad}$

$21 + 1 = \underline{\quad}$

$9 - 1 = \underline{\quad}$

$5 - 3 = \underline{\quad}$

$9 - 6 = \underline{\quad}$

$19 - 1 = \underline{\quad}$

$15 - 3 = \underline{\quad}$

$19 - 6 = \underline{\quad}$

$29 - 1 = \underline{\quad}$

$25 - 3 = \underline{\quad}$

$29 - 6 = \underline{\quad}$

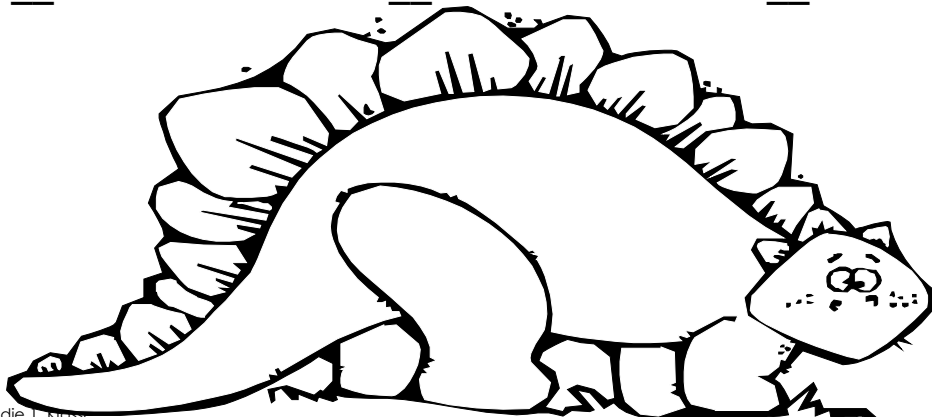

Name: _____

$1 + _ = 4$

$3 + _ = 7$

$11 + _ = 14$

$13 + _ = 17$

$21 + _ = 24$

$23 + _ = 27$

$3 + _ = 9$

$5 + _ = 10$

$13 + _ = 19$

$15 + _ = 20$

$23 + _ = 29$

$25 + _ = 30$

$7 + _ = 9$

$1 + _ = 3$

$17 + _ = 29$

$11 + _ = 13$

$27 + _ = 29$

$21 + _ = 23$

$2 + _ = 6$

$3 + _ = 3$

$12 + _ = 16$

$13 + _ = 13$

$22 + _ = 26$

$23 + _ = 23$

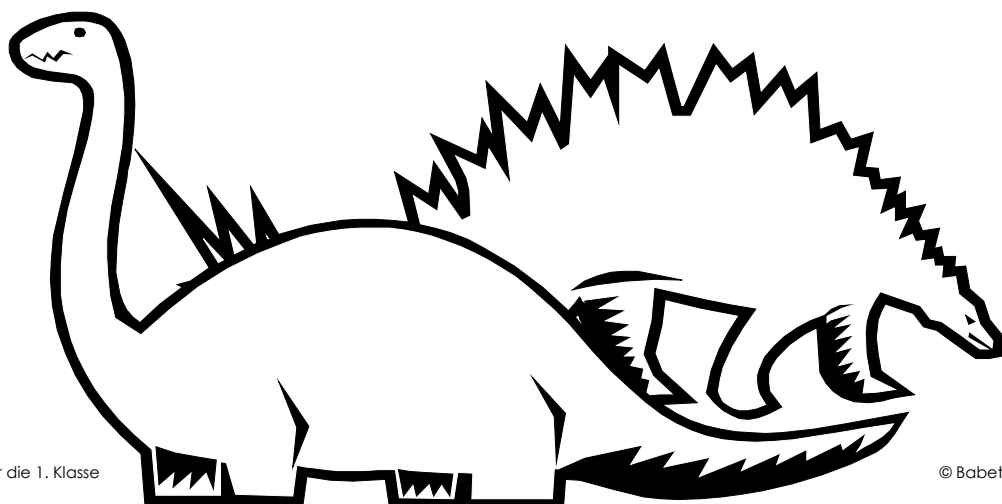

Name: _____

Achtung, jetzt musst du gut aufpassen !

$13 + 3 = \underline{\quad}$

$26 + 3 = \underline{\quad}$

$5 + 1 = \underline{\quad}$

$2 + 5 = \underline{\quad}$

$16 + 1 = \underline{\quad}$

$17 + 3 = \underline{\quad}$

$30 + 0 = \underline{\quad}$

$19 + 1 = \underline{\quad}$

$20 + 2 = \underline{\quad}$

$17 - 3 = \underline{\quad}$

$28 - 2 = \underline{\quad}$

$2 - 1 = \underline{\quad}$

$2 - 0 = \underline{\quad}$

$29 - 9 = \underline{\quad}$

$18 - 5 = \underline{\quad}$

$30 - 9 = \underline{\quad}$

$27 - 1 = \underline{\quad}$

$21 - 0 = \underline{\quad}$

$15 + 3 = \underline{\quad}$

$4 + 6 = \underline{\quad}$

$1 + 6 = \underline{\quad}$

$20 + 9 = \underline{\quad}$

$20 + 0 = \underline{\quad}$

$17 + 3 = \underline{\quad}$

$16 + 2 = \underline{\quad}$

$27 + 2 = \underline{\quad}$

$21 + 2 = \underline{\quad}$

$20 - 1 = \underline{\quad}$

$15 - 2 = \underline{\quad}$

$21 - 1 = \underline{\quad}$

$9 - 1 = \underline{\quad}$

$29 - 3 = \underline{\quad}$

$29 - 0 = \underline{\quad}$

$30 - 2 = \underline{\quad}$

$28 - 8 = \underline{\quad}$

$30 - 9 = \underline{\quad}$

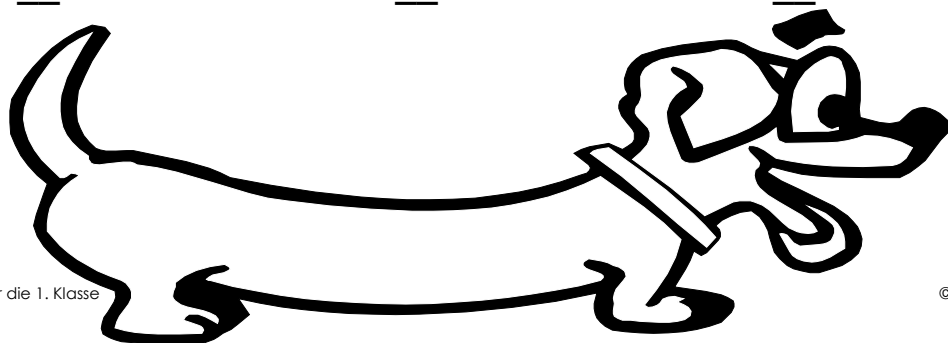

Name: _____

$2 - \underline{\quad} = 1$

$5 - \underline{\quad} = 3$

$12 - \underline{\quad} = 11$

$15 - \underline{\quad} = 13$

$22 - \underline{\quad} = 21$

$25 - \underline{\quad} = 23$

$9 - \underline{\quad} = 7$

$8 - \underline{\quad} = 5$

$19 - \underline{\quad} = 17$

$18 - \underline{\quad} = 15$

$29 - \underline{\quad} = 27$

$28 - \underline{\quad} = 25$

$8 - \underline{\quad} = 0$

$6 - \underline{\quad} = 2$

$18 - \underline{\quad} = 10$

$16 - \underline{\quad} = 12$

$28 - \underline{\quad} = 20$

$26 - \underline{\quad} = 22$

$4 - \underline{\quad} = 0$

$7 - \underline{\quad} = 5$

$14 - \underline{\quad} = 10$

$17 - \underline{\quad} = 15$

$24 - \underline{\quad} = 20$

$27 - \underline{\quad} = 25$

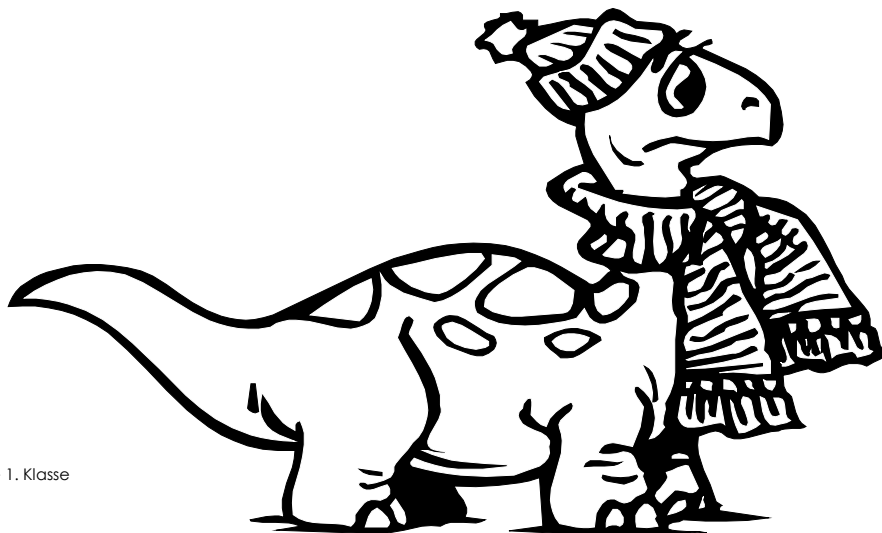

Name: _____

Übe fleißig!

$2 + 7 = \underline{\quad}$

$12 + 8 = \underline{\quad}$

$14 + 2 = \underline{\quad}$

$17 + 2 = \underline{\quad}$

$29 + 0 = \underline{\quad}$

$23 + 4 = \underline{\quad}$

$9 + 1 = \underline{\quad}$

$3 + 7 = \underline{\quad}$

$21 + 8 = \underline{\quad}$

$27 - 6 = \underline{\quad}$

$6 - 3 = \underline{\quad}$

$2 - 1 = \underline{\quad}$

$30 - 2 = \underline{\quad}$

$20 - 5 = \underline{\quad}$

$29 - 0 = \underline{\quad}$

$30 - 9 = \underline{\quad}$

$30 - 7 = \underline{\quad}$

$10 - 9 = \underline{\quad}$

$3 + 5 = \underline{\quad}$

$1 + 4 = \underline{\quad}$

$19 + 1 = \underline{\quad}$

$18 + 2 = \underline{\quad}$

$21 + 5 = \underline{\quad}$

$20 + 8 = \underline{\quad}$

$20 + 8 = \underline{\quad}$

$21 + 8 = \underline{\quad}$

$10 + 0 = \underline{\quad}$

$9 - 1 = \underline{\quad}$

$19 - 3 = \underline{\quad}$

$22 - 2 = \underline{\quad}$

$28 - 7 = \underline{\quad}$

$26 - 3 = \underline{\quad}$

$12 - 0 = \underline{\quad}$

$30 - 3 = \underline{\quad}$

$30 - 2 = \underline{\quad}$

$30 - 0 = \underline{\quad}$

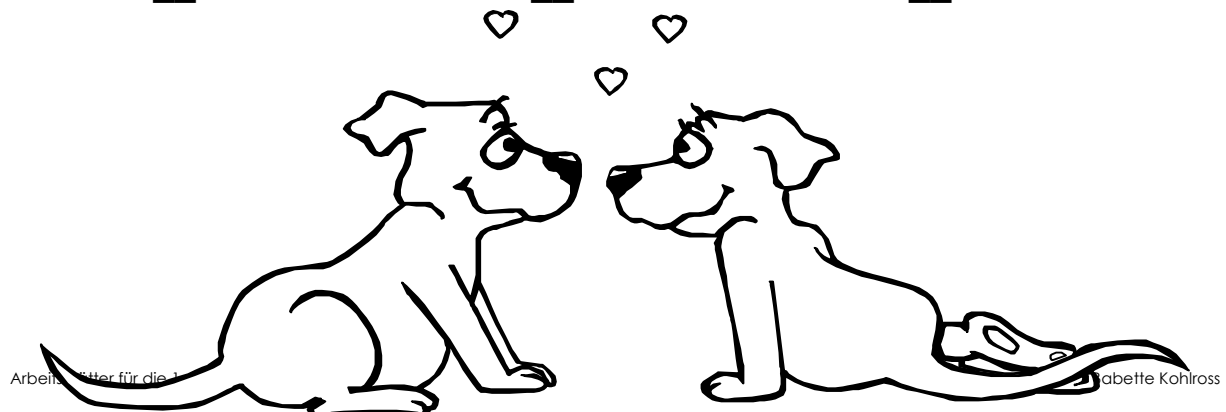

Name: _____

Kannst du das noch ?

$3 + _ = 7$

$29 + _ = 30$

$12 + _ = 16$

$27 + _ = 27$

$18 + _ = 20$

$11 + _ = 19$

$8 - _ = 6$

$23 - _ = 20$

$19 - _ = 12$

$20 - _ = 12$

$29 - _ = 23$

$30 - _ = 21$

$16 + _ = 18$

$20 + _ = 20$

$28 + _ = 29$

$19 + _ = 20$

$13 + _ = 20$

$21 + _ = 30$

$8 - _ = 0$

$23 - _ = 20$

$28 - _ = 23$

$30 - _ = 24$

$17 - _ = 11$

$16 - _ = 11$

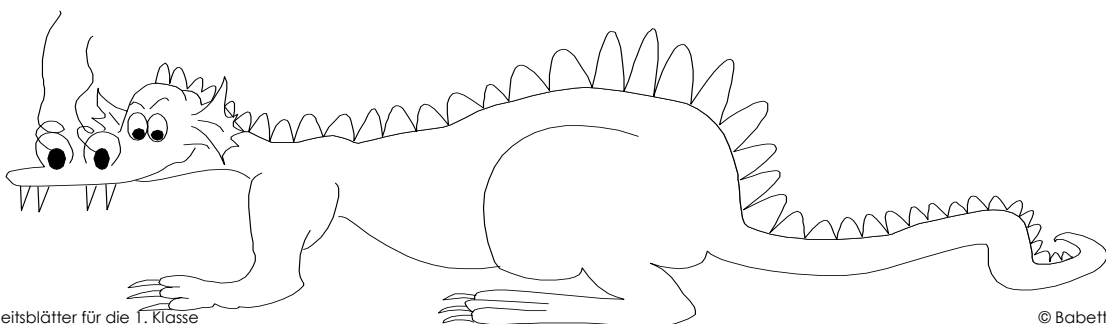

Name: _____

Kannst du das noch ?

$20 + 1 = \underline{\quad}$

$3 + 3 = \underline{\quad}$

$12 + 4 = \underline{\quad}$

$2 + 7 = \underline{\quad}$

$29 + 1 = \underline{\quad}$

$30 + 0 = \underline{\quad}$

$19 + 1 = \underline{\quad}$

$17 + 2 = \underline{\quad}$

$8 + 2 = \underline{\quad}$

$26 + 3 = \underline{\quad}$

$29 + 1 = \underline{\quad}$

$16 + 2 = \underline{\quad}$

$11 + 3 = \underline{\quad}$

$10 + 5 = \underline{\quad}$

$27 + 1 = \underline{\quad}$

$0 + 2 = \underline{\quad}$

$17 + 3 = \underline{\quad}$

$24 + 6 = \underline{\quad}$

$30 - 3 = \underline{\quad}$

$26 - 3 = \underline{\quad}$

$17 - 2 = \underline{\quad}$

$29 - 2 = \underline{\quad}$

$19 - 2 = \underline{\quad}$

$17 - 7 = \underline{\quad}$

$28 - 3 = \underline{\quad}$

$30 - 4 = \underline{\quad}$

$30 - 2 = \underline{\quad}$

$15 - 2 = \underline{\quad}$

$29 - 2 = \underline{\quad}$

$11 - 1 = \underline{\quad}$

$17 - 6 = \underline{\quad}$

$16 - 5 = \underline{\quad}$

$20 - 2 = \underline{\quad}$

$30 - 2 = \underline{\quad}$

$29 - 8 = \underline{\quad}$

$26 - 6 = \underline{\quad}$

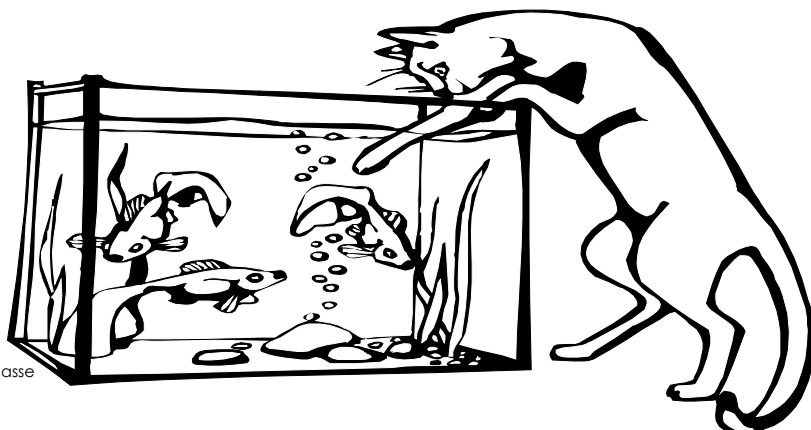

Name: _____

$21 + 0 = \underline{\quad}$

$21 + 1 = \underline{\quad}$

$21 + 2 = \underline{\quad}$

$21 + 3 = \underline{\quad}$

$21 + 4 = \underline{\quad}$

$21 + 5 = \underline{\quad}$

$21 + 6 = \underline{\quad}$

$21 + 7 = \underline{\quad}$

$21 + 8 = \underline{\quad}$

$21 + 9 = \underline{\quad}$

$22 + 0 = \underline{\quad}$

$22 + 1 = \underline{\quad}$

$22 + 2 = \underline{\quad}$

$22 + 3 = \underline{\quad}$

$22 + 4 = \underline{\quad}$

$22 + 5 = \underline{\quad}$

$22 + 6 = \underline{\quad}$

$22 + 7 = \underline{\quad}$

$22 + 8 = \underline{\quad}$

$23 + 0 = \underline{\quad}$

$23 + 1 = \underline{\quad}$

$23 + 2 = \underline{\quad}$

$23 + 3 = \underline{\quad}$

$23 + 4 = \underline{\quad}$

$23 + 5 = \underline{\quad}$

$23 + 6 = \underline{\quad}$

$23 + 7 = \underline{\quad}$

$24 + 0 = \underline{\quad}$

$24 + 1 = \underline{\quad}$

$24 + 2 = \underline{\quad}$

$24 + 3 = \underline{\quad}$

$24 + 4 = \underline{\quad}$

$24 + 5 = \underline{\quad}$

$24 + 6 = \underline{\quad}$

$25 + 0 = \underline{\quad}$

$25 + 1 = \underline{\quad}$

$25 + 2 = \underline{\quad}$

$25 + 3 = \underline{\quad}$

$25 + 4 = \underline{\quad}$

$25 + 5 = \underline{\quad}$

$26 + 0 = \underline{\quad}$

$26 + 1 = \underline{\quad}$

$26 + 2 = \underline{\quad}$

$26 + 3 = \underline{\quad}$

$26 + 4 = \underline{\quad}$

$27 + 0 = \underline{\quad}$

$27 + 1 = \underline{\quad}$

$27 + 2 = \underline{\quad}$

$27 + 3 = \underline{\quad}$

$28 + 0 = \underline{\quad}$

$28 + 1 = \underline{\quad}$

$28 + 2 = \underline{\quad}$

$29 + 0 = \underline{\quad}$

$29 + 1 = \underline{\quad}$

$30 + 0 = \underline{\quad}$

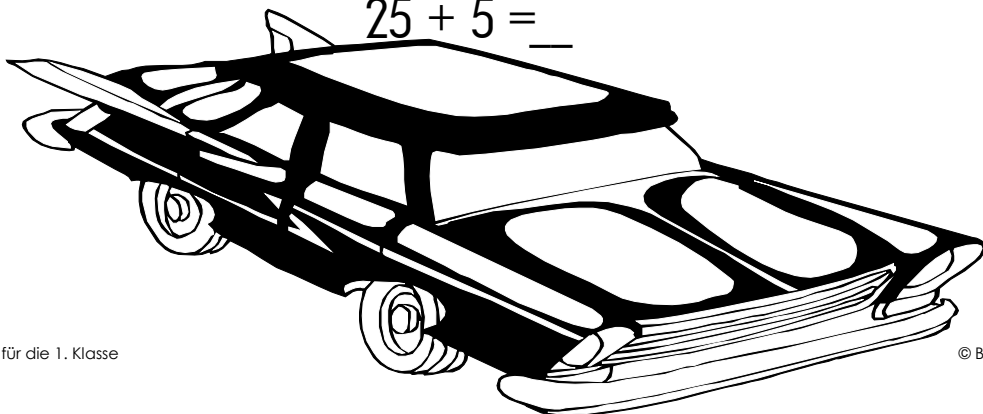

Name: _____

$12 + 3 = \underline{\quad}$

$2 + 6 = \underline{\quad}$

$22 + 2 = \underline{\quad}$

$17 + 1 = \underline{\quad}$

$27 + 3 = \underline{\quad}$

$7 + 2 = \underline{\quad}$

$5 + 3 = \underline{\quad}$

$25 + 4 = \underline{\quad}$

$15 + 1 = \underline{\quad}$

$21 + 6 = \underline{\quad}$

$1 + 9 = \underline{\quad}$

$11 + 5 = \underline{\quad}$

$8 + 2 = \underline{\quad}$

$18 + 0 = \underline{\quad}$

$28 + 1 = \underline{\quad}$

$16 + 4 = \underline{\quad}$

$26 + 3 = \underline{\quad}$

$6 + 0 = \underline{\quad}$

$3 + 2 = \underline{\quad}$

$13 + 7 = \underline{\quad}$

$23 + 5 = \underline{\quad}$

$14 + 5 = \underline{\quad}$

$4 + 6 = \underline{\quad}$

$24 + 3 = \underline{\quad}$

$29 + 1 = \underline{\quad}$

$9 + 0 = \underline{\quad}$

$19 + 1 = \underline{\quad}$

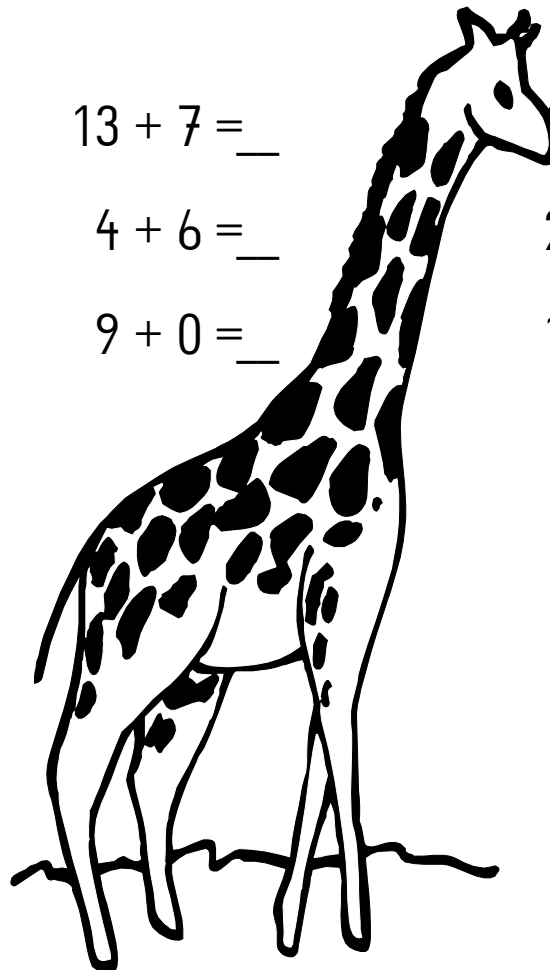

Name: _____

$17 - 2 = \underline{\quad}$

$28 - 3 = \underline{\quad}$

$9 - 2 = \underline{\quad}$

$28 - 5 = \underline{\quad}$

$30 - 2 = \underline{\quad}$

$27 - 6 = \underline{\quad}$

$10 - 2 = \underline{\quad}$

$4 - 4 = \underline{\quad}$

$19 - 2 = \underline{\quad}$

$28 - 8 = \underline{\quad}$

$16 - 3 = \underline{\quad}$

$9 - 2 = \underline{\quad}$

$30 - 2 = \underline{\quad}$

$2 - 2 = \underline{\quad}$

$17 - 2 = \underline{\quad}$

$25 - 3 = \underline{\quad}$

$19 - 2 = \underline{\quad}$

$15 - 3 = \underline{\quad}$

$27 - 2 = \underline{\quad}$

$1 - 0 = \underline{\quad}$

$22 - 2 = \underline{\quad}$

$10 - 2 = \underline{\quad}$

$30 - 3 = \underline{\quad}$

$25 - 4 = \underline{\quad}$

$18 - 3 = \underline{\quad}$

$14 - 2 = \underline{\quad}$

$16 - 3 = \underline{\quad}$

